

Nominal voltage	12 V	
Nominal capacity	120,0 Ah @ C20 to 1,75 V/cell	
Dimensions	Length	407 mm
	Width	177 mm
	Height / Total height	225 / 225 mm
Weight	~ 35,5 kg	
Technology	VRLA (Valve Regulated Lead Acid) Electrolyte - GEL	
Design life time	15 years (standby use)	
Internal resistance	~ 7,0 mΩ (full charged)	
Operating temperature range	Discharge	-40°C ~ +60°C
	Charge	-20°C ~ +50°C
	Storage	-40°C ~ +60°C
Maximum discharge current	1 200 A (5 sec.)	
Recommended maximum charging current	24,0 A	
Charging voltage	Standby use	13,6 ~ 13,8 VDC
	Cycle use	14,2 ~ 14,4 VDC
Self discharge	Monthly is less than 2% at 25°C	
Container material	ABS UL94HB (optional UL94-V0)	
Terminal types	Internal thread M8 (breaking torque 10-12 Nm)	

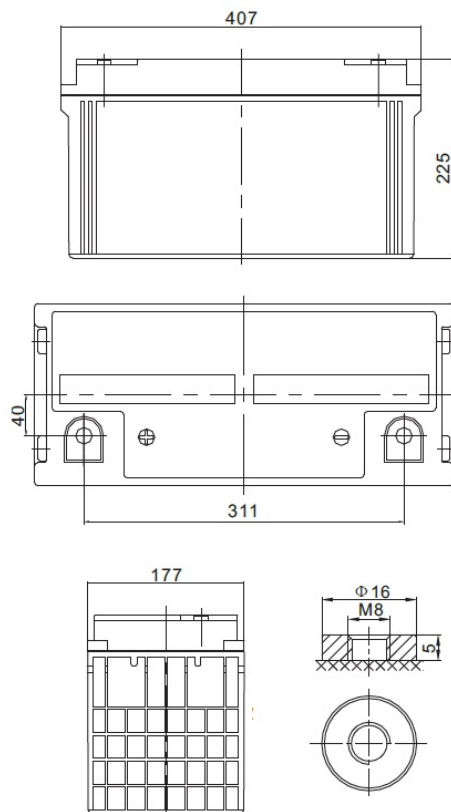

CONSTANT CURRENT DISCHARGE CHARACTERISTICS (A at 25°C)

Voltage / Time	10 min	15 min	30 min	1 h	2 h	3 h	4 h	5 h	8 h	10 h	20 h
9.6 V	204,50	164,20	110,00	67,10	40,10	27,70	22,70	18,60	12,80	10,80	6,60
10.0 V	194,60	160,80	109,10	66,80	39,80	27,60	22,60	18,50	12,70	10,70	6,40
10.2 V	187,70	158,30	108,40	66,10	39,50	27,40	22,50	18,40	12,60	10,60	6,20
10.5 V	175,30	152,50	106,70	65,50	39,20	27,30	22,30	18,20	12,50	10,50	6,00
10.8 V	161,70	142,20	103,00	64,00	38,50	26,60	21,80	17,80	12,30	10,40	5,60
11.1 V	146,20	129,00	97,40	60,80	36,80	25,40	20,70	17,10	11,80	10,10	5,40

CONSTANT POWER DISCHARGE CHARACTERISTICS (W at 25°C)

Voltage / Time	10 min	15 min	30 min	1 h	2 h	3 h	4 h	5 h	8 h	10 h	20 h
9.6 V	2178,3	1806,1	1254,3	775,1	473,1	330,3	271,0	222,0	153,1	129,5	70,0
10.0 V	2111,5	1777,1	1240,0	773,3	470,6	330,3	270,7	221,5	152,3	128,7	68,8
10.2 V	2055,8	1757,1	1243,3	767,3	467,7	328,8	270,1	220,7	151,3	127,6	67,5
10.5 V	1937,1	1695,7	1226,2	760,4	464,4	327,5	267,6	218,1	150,1	126,3	66,3
10.8 V	1806,6	1585,5	1186,7	746,4	458,4	318,6	261,5	214,1	147,6	125,1	65,0
11.1 V	1652,4	1443,7	1125,3	714,4	441,4	304,9	248,8	204,9	141,3	121,3	61,2

According with:

PN-EN 60896-21:2007	ISO 9001
PN-EN 60896-22:2007	ISO 14001
PN-EN 61056-1:2013	
PN-EN 61056-2:2013	
PN-E-83016:1999	

EFFECT OF TEMPERATURE ON LONG TERM LIFE

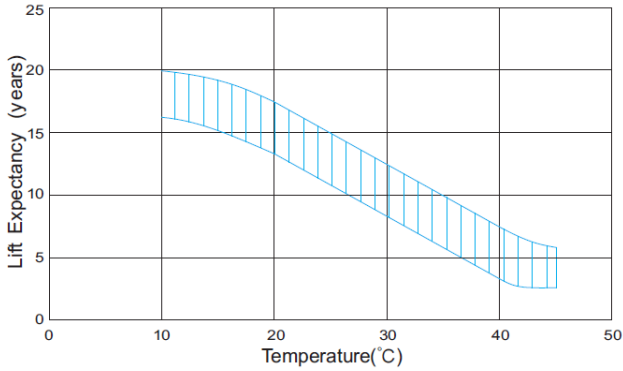

CYCLE LIFE IN RELATION TO DEPTH OF DISCHARGE

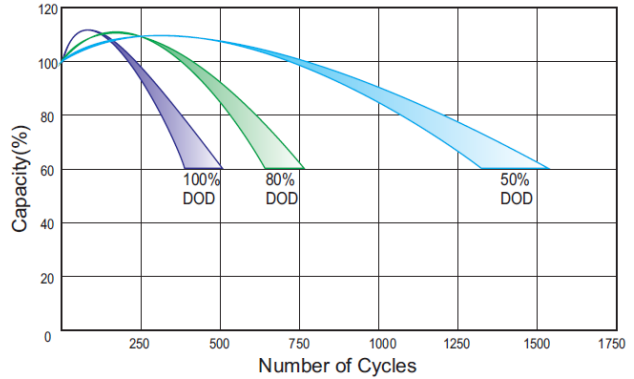

DISCHARGE CHARACTERISTICS

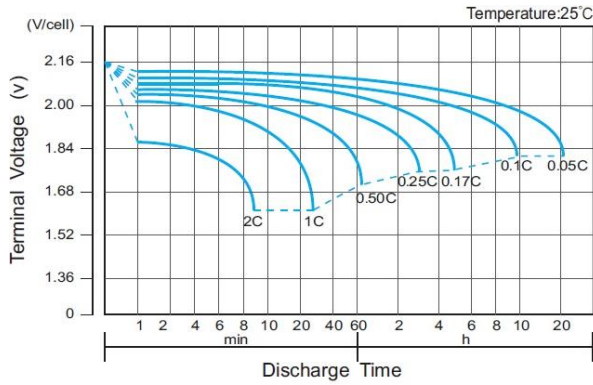

CHARGE CHARACTERISTIC FOR STANDBY USE

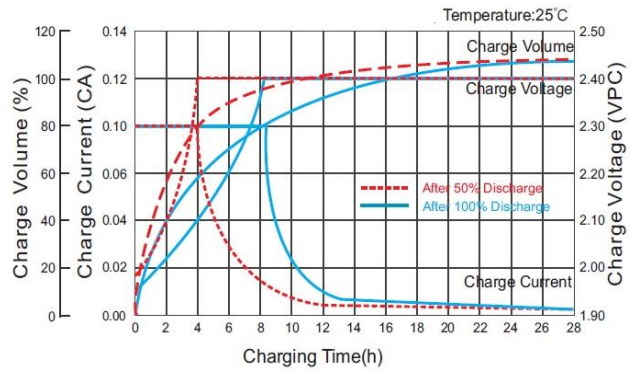

RELATIONSHIP BETWEEN CHARGING VOLTAGE AND TEMPERATURE

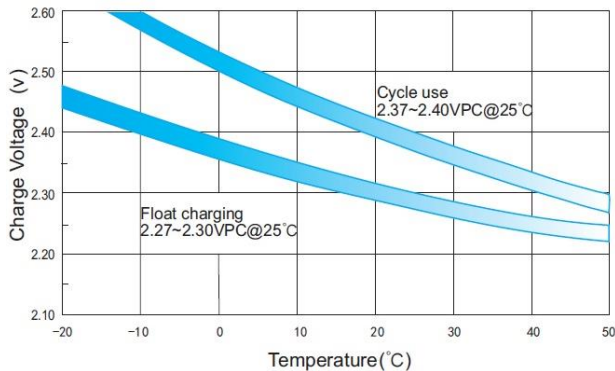

STORAGE CHARACTERISTICS

